

LOGICOM

REPAIR MANUAL/MANUEL DE RÉPARATION

VISION X3 & VISION X3 MAX

ID Picture/ Photo d'identité



LOGICOM

Route Map / Carte routière

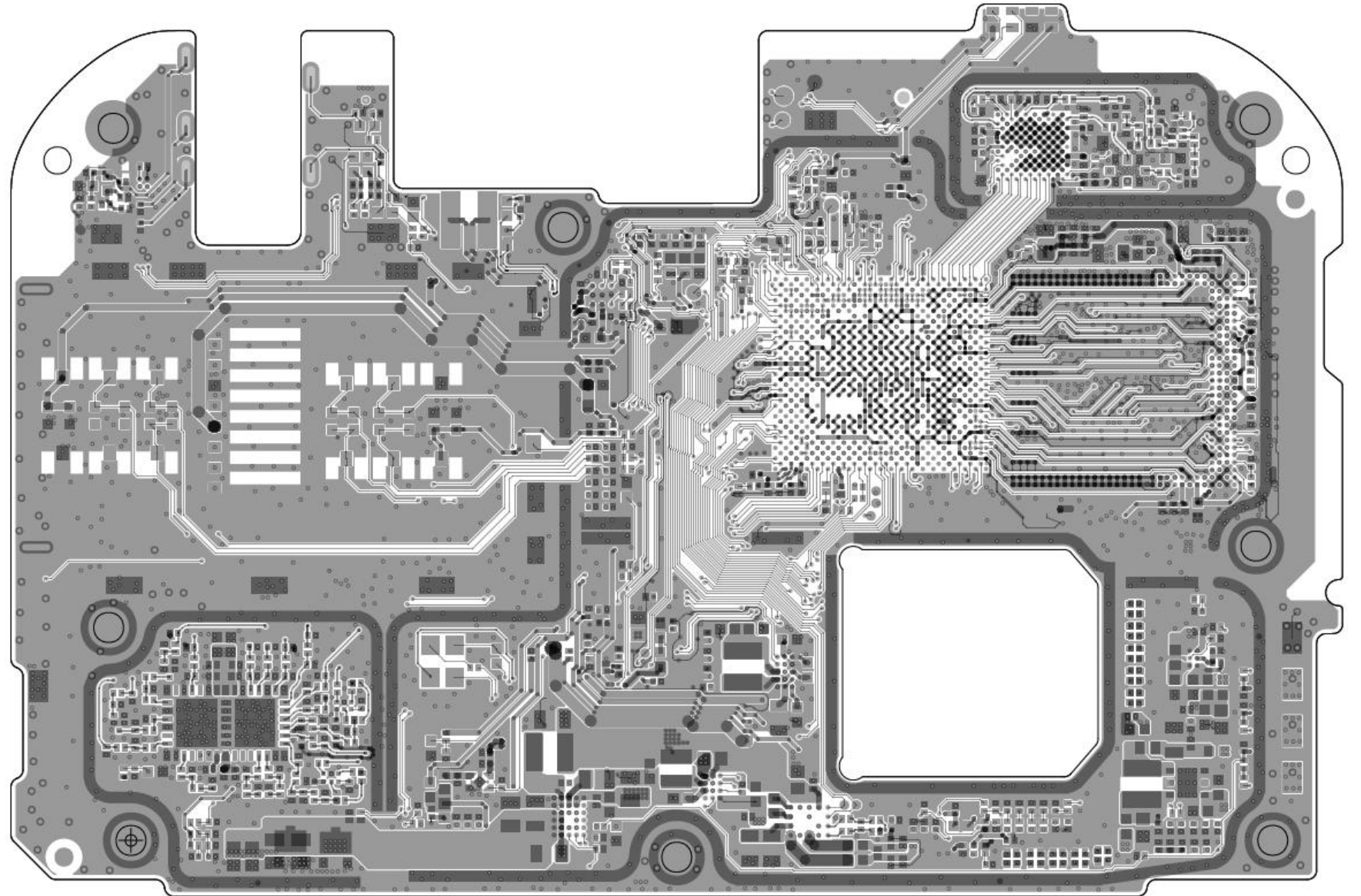

LOGICOM

Route Map / Carte routière

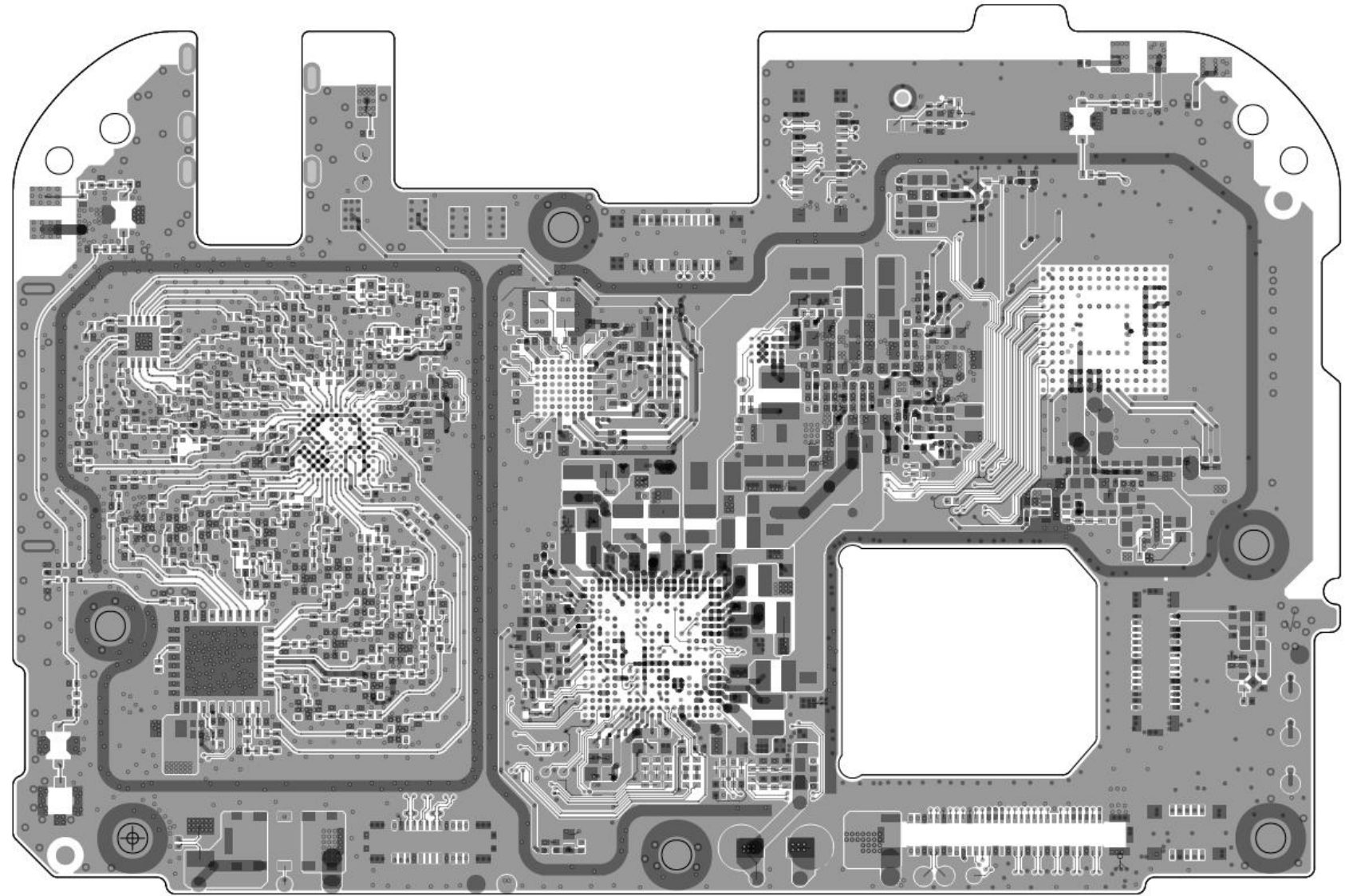

LOGICOM

Route Map / Carte routière



Motherboard
Schematic Loc

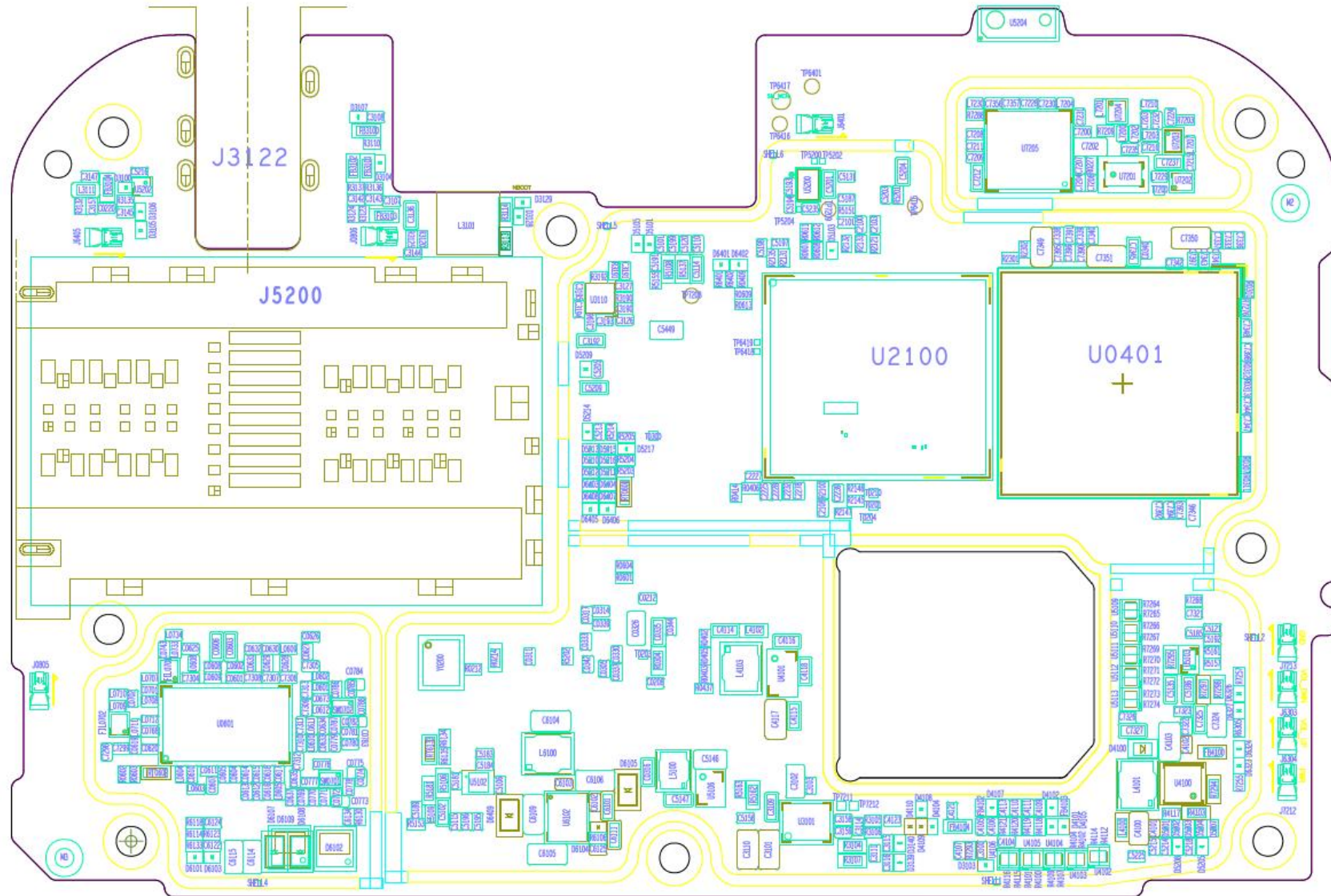





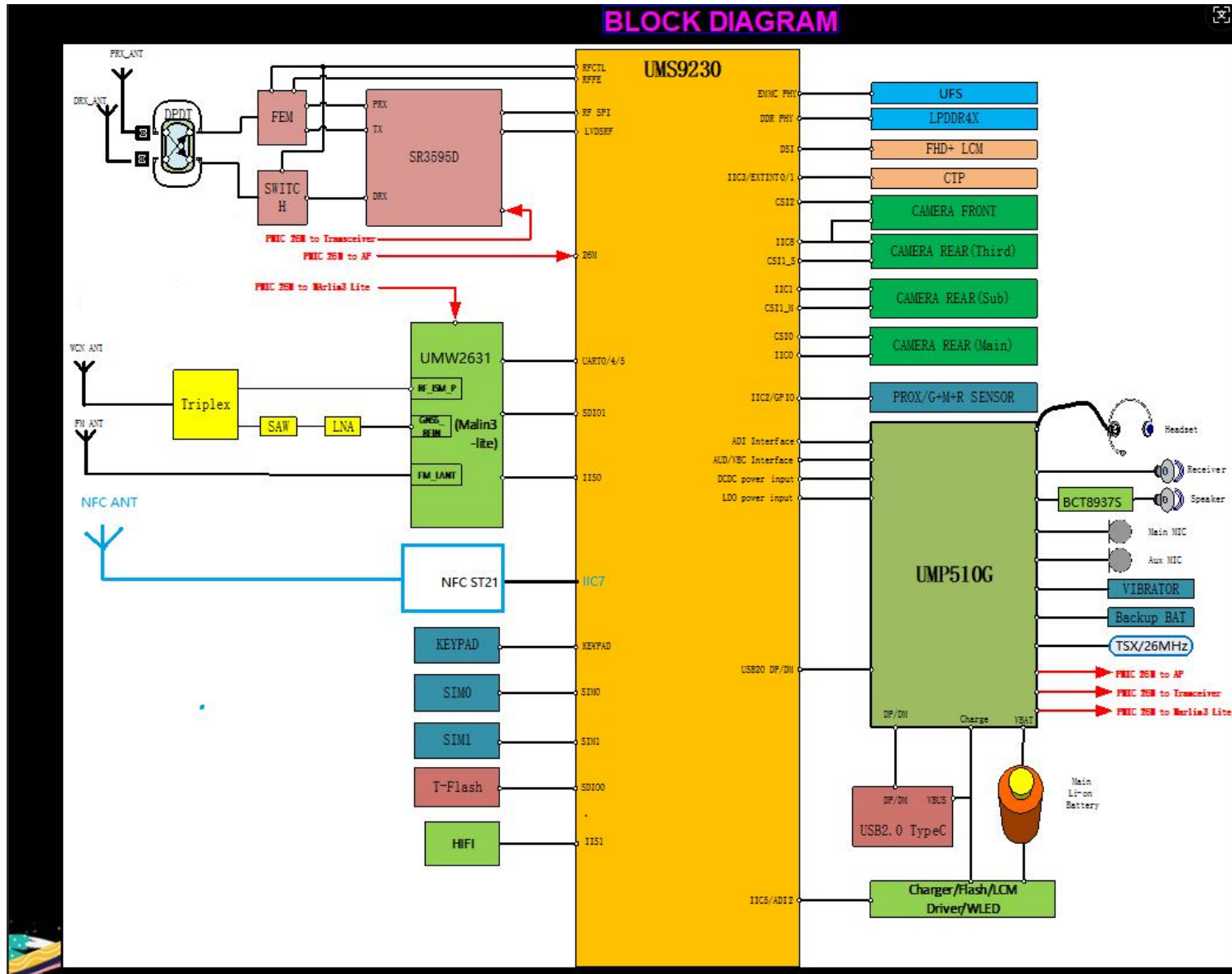





LOGICOM

Block diagram/ Diagramme fonctionnel



Tools to be prepared / Outils nécessaires

schematic diagram for repair					
Name	schematic diagram	Name	schematic diagram	Name	schematic diagram
Plastic crowbar		Disassembly piece		sucker	
cross-head screwdriver		Brush		Anhydrous Alcohol	
Soldering Iron		Heat Gun		magnifying glass	
Multimeter		DC regulated power supply			

Precautions / Précautions

Maintenance Precautions

Disconnect Power First: Remove the battery or disconnect the power flex cable when accessible. If inaccessible, take measures to minimize voltage hazards.



ESD Protection: Wear an ESD wrist strap and ensure proper grounding; use an anti-static mat on the work surface.

Screw Management: Keep screws organized by area (take photos + use separate compartments). Mixing screws of different lengths can damage the motherboard.



Do not use metal tweezers to handle the battery: the internal component is lithium, and puncturing the membrane with metal can cause a fire or explosion."

Do not short the red and black leads while measuring voltage, as this will damage the motherboard components.



STEP 1: Disassembly battery cover

Operating steps		Operation diagram and instructions	
Operating Content	<p>1. use a Opening tools of Plastic sheet to separate the bottom of the battery cover and pull it upward to separate the battery cover and the phone middle frame, ensuring the opening tool can be inserted into the gap. (See Diagram 1)</p> <p>2. Insert the opening tool of Plastic sheet into the gap between the battery cover and the phone frame, and separate the adhesive of the battery cover from the phone frame in the direction of the arrow. Finally, remove the battery cover completely. (See Diagram 2)</p> <p>3. After the battery cover is removed, proceed to the next disassembly step.</p>	<p>Diagram 1</p> 	<p>Diagram 2</p> 
Quality Control Point (QCP)	<p>Plastic opening tools must be used to prevent the phone from being scratched.</p>		

STEP 2: disassembly screw

Operating steps		illustration diagram and instructions	
Operating Content	<ol style="list-style-type: none">1.Prepare a screwdriver and remove all 16 screws marked in the red circles as shown in Diagram 12.Use a SIM ejector tool to remove the SIM card tray as shown in Diagram 2.3.After removing the screws, proceed to the next disassembly step.	<p>Diagram 1</p> 	<p>Diagram 2</p> 
Quality Control Point (QCP)	<p>The screwdriver bit should be a PH0 type with a cutting edge diameter of approximately 3mm.</p>		



STEP 3: disassembly middle cover

Operating steps		illustration diagram and instructions	
Operating Content	<p>1.Prepare an opening tool, insert it into the gap between the power button/volume button interface and the midframe, then separate the front cover from the midframe by sliding along the arrow's direction (as shown in Diagram 1).</p> <p>2.After removing the midframe(as shown in Diagram 2), proceed to the next disassembly step.</p>	<p>Diagram 1</p> 	<p>Diagram 2</p> 
Quality Control Point (QCP)			



STEP 4: disassembly FPC

Operating steps		illustration diagram and instructions
Operating Content	According to the sequence marked in the image, use the opening tool to remove the battery FPC, camera FPC, and display FPC one by one.	
Quality Control Point (QCP)	The FPC on the battery connector must be removed first, followed by the FPC cables of the camera and display.	



STEP 5: disassembly mainboard

Operating steps		illustration diagram and instructions	
Operating Content	According to the arrow position marked in the image, use a pry tool to lift the motherboard to an 80-degree angle and then remove it from the front casing.		
Quality Control Point (QCP)			



STEP 6: disassembly Sub-board

Operating steps		illustration diagram and instructions	
Operating Content	<ol style="list-style-type: none">1.Remove the coaxial cable and display FPC cable in sequence at the positions marked 1 and 2 in the diagram.2.Use a screwdriver to remove the small board screw at the position marked 3 in the image.3.Detach the Sub-board from the front casing and remove the USB dust cover.	<p>Diagram 1</p> 	<p>Diagram 2</p> 
Quality Control Point (QCP)			

STEP 7: disassembly battery

Operating steps		illustration diagram and instructions	
Operating Content	<ol style="list-style-type: none">1. Tear off the pull tabs on both ends of the battery.2. After removing the pull tabs, take the battery out.	<p>Diagram 1</p> 	<p>Diagram 2</p> 
Quality Control Point (QCP)			

STEP 8: disassembly motor speaker, receiver

Operating steps		illustration diagram and instructions
<p>Operating Content</p> <ol style="list-style-type: none"> 1. Use metal tweezers to remove the motor. 2. Use Disassembly stick to remove the speaker. 3. Use Disassembly stick to remove the receiver. 		<div style="display: flex; justify-content: space-around; text-align: center;"> <div data-bbox="1518 539 1666 579"> <p>Speaker</p>  </div> <div data-bbox="1839 539 1987 579"> <p>Motor</p>  </div> <div data-bbox="2181 539 2328 579"> <p>Receiver</p>  </div> </div>
<p>Quality Control Point (QCP)</p> <p>The action of removal will only be performed if it is confirmed that the motor/speaker/receiver needs to be replaced; otherwise, there is no need to remove them.</p>		





Components List / Liste des composants

Item Component name







1. main board
2. back housing
3. side key
4. back main camera
5. front camera
6. back sub camera
7. sub board
8. usb sleeve
9. main camera sleeve
10. earphone jacket sleeve
11. camera lens
12. screw
13. RF cable
14. side key FPC
15. main Antenna
16. Multi-band Antenna
17. WiFi BT antenna
18. SIM card tray
19. receiver
20. screen
21. back housing
22. motor
23. battery
24. speaker
25. motor





Components List / Liste des composants

item	Item Component name (EN)	Nom du composant (FR)	Picture	illustrate
1	Back cover	Coque arrière		
2	PCBA Bracket	Support PCBA		There is no PCBA bracket; the PCBA is supported by the front cover.
3	Back housing waterproof part	Pièce étanche du boîtier arrière		The back housing waterproofing is achieved by the battery cover foam
4	Front housing	Boîtier avant		
5	Back housing	Boîtier arrière		

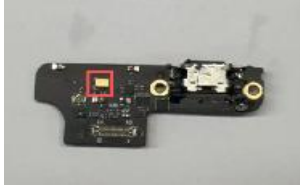

Components List / Liste des composants

6	USB waterproof plug	Bouchon étanche USB		
7	LTE antenna bracket	Support d'antenne LTE		There is no antenna bracket; the antenna is secured to the back housing
8	DOME	Dôme		The DOME is located on the side key FPC
9	Rear Camera	Caméra arrière		
10	Motor	Moteur		

Components List / Liste des composants

11	Mic	Micro		The microphone is located on the sub board
12	Speaker	Haut-parleur		
13	Receiver	Écouteur		
14	Buttons	Boutons		
15	Metal side bar	Barre latérale métallique		there is no Metal side bar

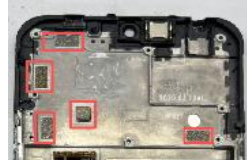
Components List / Liste des composants

16	Corner cover	Cache d'angle		there is no Corner cover
17	PCBA conductive cloth	Tissu conducteur PCBA	 A photograph of a smartphone's internal printed circuit board (PCBA) with several red rectangular boxes highlighting specific conductive areas.	The PCBA conductive cloth is located on the front cover
18	Speaker cavity foam	Mousse de la cavité du haut-parleur	 A photograph of a small, rectangular, white foam component used for speaker cavity support.	The Speaker cavity foam is fixed on the Speaker
19	LCD IC support foam	Mousse de support IC LCD		There is no LCD IC support foam
20	PCBA	PCBA	 A photograph of a smartphone's main printed circuit board (PCBA) showing various components and connectors.	

Components List / Liste des composants

20	PCBA	PCBA		
21	LCD	LCD		
22	LED	LED		
23	Bluetooth line	Câble Bluetooth		There is no Bluetooth line
24	Camera lens	Lentille de la caméra		
25	LED lens	Lentille LED		

Components List / Liste des composants

26	Main lens	Lentille principale		
27	Side strip pin conductive foam	Mousse conductrice pour pin de bande latérale		There is no Side strip pin conductive foam
28	Chamfered screw	Vis chanfreinée		
29	Side pin	Goupille latérale		
30	Antenna / PCBA bracket screw	Vis du support d'antenne / PCBA		

Components List / Liste des composants

31	Metal side bar screw	Vis de la barre latérale métallique		There is no Metal side bar screw
32	Back cover screw	Vis du couvercle arrière		
33	LCD pressing foam	Mousse de maintien LCD		There is no LCD pressing foam
34	Camera pad insulation adhesive	Colle isolante pour pastilles de caméra		There is no Camera pad insulation adhesive. The insulation adhesive is achieved by the Silicone cover.

Fault Diagnosis / Reset Steps

Étapes de diagnostic des pannes / de réinitialisation

Common Fault Diagnosis and Repair Guide (Fault → Troubleshooting → Resolution)

Power-on Failure

Troubleshooting	Resolution
Check the charging cable, charging head, and power outlet.	Test with a different cable, adapter, and power outlet.
Check if the buttons are functional.	Connect the charger and charge for 15 to 20 minutes.
No response when the power button is pressed.	Perform a forced restart (Press and hold the Power button for 20 seconds).
Check if there is any response when charging.	Perform a forced restart (Press and hold the Power button for 20 seconds).
Check the battery voltage; it should remain between 3.7V and 4.35V. If the voltage is below 3.3V, the battery is likely damaged.	Replace the battery.
Check the battery flex cable and the screen flex cable.	Re-seat all connectors (Many non-boot issues are simply due to loose cables). Inspect the flex cables for breaks or creases.
Check the motherboard for water damage, corrosion, or burn marks.	For water-damaged devices, prioritize cleaning the motherboard (using anhydrous alcohol + a brush).
Check motherboard current: 0mA (completely unresponsive).	Replace faulty flex cables, the power button, or the motherboard.
Check motherboard current: fluctuating between 0-50mA.	Replace the motherboard Power IC, CPU, or (RAM).
Check motherboard current: rises to 100–150mA and then stops.	
Check motherboard current: above 1A (short circuit on the motherboard).	In case of motherboard short circuit, cut the power immediately. Attempt to replace the Power IC, Audio IC, Display Power Supply MOSFET, or filter capacitors.

Fault Diagnosis / Reset Steps

Étapes de diagnostic des pannes / de réinitialisation

4.2 Screen Failure	
Troubleshooting	Resolution
The phone vibrates or makes sounds when turned on, but the screen remains black.	Restart steps 1. Press and hold the Power button (on the right or top of the phone) for 10–15seconds. 2. The power menu pops up on the screen; tap Restart. 3. The phone will shut down and boot up automatically to finish restarting.
	Re-download the mobile phone system software
Loose flex cable	Reconnect the flex cable (unplug and plug it back in).
Damaged flex cable	Replace the damaged screen flex cable.
screen is cracked, has liquid leakage, or is flickering.	Open the phone and replace the screen assembly.
The phone is on, but the screen is not displaying anything.	If the backlight is damaged, you need to open the phone and replace the screen assembly.

Fault Diagnosis / Reset Steps

Étapes de diagnostic des pannes / de réinitialisation

No charging or slow charging Failure	
Troubleshooting	Resolution
Check if the Type-C charging port is clogged with dust, exposed to water, or oxidized	Clean the phone's Type-C charging port with a soft brush and a small amount of anhydrous alcohol (power off first).
Check if the Type-C charging cable and charger are functioning properly	Replace the Type-C charging cable or charger.
Check if the flex cables on the mainboard and sub-board are loose, and if the solder joints have cold solder (or dry joints).	Reconnect the flex cables on the motherboard and sub-board (re-seat), or replace the flex cables.
Check that the battery voltage remains between 3.7V and 4.35V. If the voltage is below 3.3V, the battery is likely damaged."	Replace the battery.
The charging IC (Power Management IC / PMIC) or the charging protection MOSFET on the motherboard is damaged.	Replace the charging IC
	Replace the charging protection MOSFET
	Replace the motherboard assembly

Fault Diagnosis / Reset Steps

Étapes de diagnostic des pannes / de réinitialisation

No communication signal; unable to make calls or weak signal Failure.	
Troubleshooting	Resolution
The phone is re-searching for signal.	Turn on Airplane Mode for 5 seconds, then turn it off again.
Restart the phone.	<p style="text-align: center;">Restart steps</p> 1. Press and hold the Power button (on the right or top of the phone) for 10–15 seconds. 2. The power menu pops up on the screen; tap Restart. 3. The phone will shut down and boot up automatically to finish restarting.
Check if there is an outstanding balance or if the service is restricted by the carrier.	Call the carrier's customer service to confirm.
Check network settings.	step: Settings → System → Reset → Reset Network Settings.
SIM card is damaged.	Replace the SIM card.
Check if the SIM card or SIM card slot is oxidized	Clean the SIM card and SIM tray with a soft brush and a small amount of anhydrous alcohol (while powered off).
Disassemble the phone to check if the antenna clip is loose or if the antenna contact pins are deformed.	Reconnect the antenna connector, or repair and replace the antenna shrapnel.
Disassemble the phone to inspect if the antenna FPC (Flexible Printed Circuit) attached to the middle frame is damaged.	Replace the antenna FPC (Flexible Printed Circuit).
Damage to the baseband power IC or RF (Radio Frequency) IC on the motherboard.	Replace the baseband power IC and RF IC.
Motherboard components are damaged.	Replace the motherboard components.
System file damage causing signal loss.	Re-download the phone's system software.

Fault Diagnosis / Reset Steps

Étapes de diagnostic des pannes / de réinitialisation

camera Failure	
Troubleshooting	Resolution
A frozen camera app or insufficient system resources can cause the camera to fail to open.	Restart steps 1.Press and hold the Power button (on the right or top of the phone) for 10–15seconds. 2.The power menu pops up on the screen; tap Restart. 3.The phone will shut down and boot up automatically to finish restarting.
Clear the camera app cache.	Step: Settings → Apps → Camera → Storage → Clear Cache
Check camera permissions.	Step: Settings → Apps → Camera → Permissions → Enable "Camera Access" / "Camera Permission"
The camera screen is black, but an error message appears saying "Camera is occupied" or "Can't connect to the camera."	Restart the phone or disassemble it to re-seat the camera flex cable.
Neither the front nor the rear camera is working.	Replace the camera module
Damage to the camera power IC on the motherboard.	Replace the camera power IC on the motherboard
Damage to the CPU on the motherboard.	Replace the CPU on the motherboard
Damage to the motherboard components.	Replace the motherboard components

Fault Diagnosis / Reset Steps

Étapes de diagnostic des pannes / de réinitialisation

audio Failure	
Troubleshooting	Resolution
Check Mute Mode	Turn off the silent mode switch
System lag/freezing may cause the speaker or earpiece to be silent.	Restart steps 1.Press and hold the Power button (on the right or top of the phone) for 10–15seconds. 2.The power menu pops up on the screen; tap Restart. 3.The phone will shut down and boot up automatically to finish restarting.
Check if a Bluetooth device is connected.	Turn off Bluetooth
Speaker has low volume, noise, or distortion.	Replace the speaker
Earpiece has low volume, noise, or distortion.	Replace the receiver
Microphone is not functioning.	Replace the microphone on the motherboard or replace the motherboard assembly
Audio IC issue on the motherboard.	Replace the audio codec IC
Motherboard component issue.	Replace the motherboard assembly

Fault Diagnosis / Reset Steps

Étapes de diagnostic des pannes / de réinitialisation

WiFi and Bluetooth failure	
Troubleshooting	Resolution
System freezes can prevent WiFi and Bluetooth from turning on.	Restart steps 1. Press and hold the Power button (on the right or top of the phone) for 10–15 seconds. 2. The power menu pops up on the screen; tap Restart. 3. The phone will shut down and boot up automatically to finish restarting.
Check the WiFi/Bluetooth toggle.	Step: Power On → Power Off → Power On again to allow the module to re-initialize.
Reset network settings.	Step: Settings → System → Reset → Reset Network Settings.
System bugs can cause abnormalities in the WiFi and Bluetooth modules.	Update System
Check if the WiFi/Bluetooth MAC address is available.	Step: Settings → About Phone → WiFi / Bluetooth MAC Address.
Antenna damage or poor connection.	Disassemble the phone to replace the Antenna FPC or replace the motherboard pogo pins.
WiFi/Bluetooth module damage.	Replace the WiFi/BT Chip on the motherboard.

Required Information/ Informations requises

INFORMATION REQUIREMENTS	
From 20 June 2025:	Based on actual product
Manufacturers, importers or authorised representatives shall provide in the technical documentation and make publicly available on free access websites of the manufacturer, importer or authorised representative the following information:	The device is compatible with FAT12/16, FAT32, and extra FAT file systems. While the official specification supports a maximum 128GB storage card, 256GB and 512GB cards are theoretically supported
compatibility with removable memory cards, if any	not available
indicative weight range of the following critical raw materials and environmentally relevant materials:	The machine's inherent tolerance is around $\pm 5g$.
cobalt in the battery (weight range: less than 2 g, between 2 g and 5 g, above 5 g)	>5g
tantalum in capacitors (weight range: less than 0,05 g, between 0,05 g and 0,2 g, above 0,2 g)	0.05g~0.2g
neodymium in loud speakers, vibration motors, and other magnets (weight range: less than 0,05 g, between 0,05 g and 0,2 g, above 0,2 g)	>0.2g
gold in all components (weight range: less than 0,02 g, between 0,02 g and 0,1 g, above 0,1 g).	>0.1g
the indicative value of the recyclability rate R _{cyc}	not available
the indicative percentage of recycled content for the product or a part thereof, where available; if not available, the recycled content should be indicated as "not known" or "not available"	not available

Required Information/ Informations requises

INFORMATION REQUIREMENTS	
From 20 June 2025:	Based on actual product
Manufacturers, importers or authorised representatives shall provide in the technical documentation and make publicly available on free access websites of the manufacturer, importer or authorised representative the following information:	The device is compatible with FAT12/16, FAT32, and extra FAT file systems. While the official specification supports a maximum 128GB storage card, 256GB and 512GB cards are theoretically supported
compatibility with removable memory cards, if any	not available
indicative weight range of the following critical raw materials and environmentally relevant materials:	The machine's inherent tolerance is around $\pm 5g$.
cobalt in the battery (weight range: less than 2 g, between 2 g and 5 g, above 5 g)	>5g
tantalum in capacitors (weight range: less than 0,05 g, between 0,05 g and 0,2 g, above 0,2 g)	0.05g~0.2g
neodymium in loud speakers, vibration motors, and other magnets (weight range: less than 0,05 g, between 0,05 g and 0,2 g, above 0,2 g)	>0.2g
gold in all components (weight range: less than 0,02 g, between 0,02 g and 0,1 g, above 0,1 g).	>0.1g
the indicative value of the recyclability rate R_{cyc}	not available
the indicative percentage of recycled content for the product or a part thereof, where available; if not available, the recycled content should be indicated as "not known" or "not available"	not available

Required Information/ Informations requises

ingress protection rating	IP44
minimum battery endurance in cycles in number of cycles	Rated Battery Capacity: 5000 mAh
	Cycle : 1000 cycles
in case of foldable devices, it shall be indicated that “This device did not undergo a scratch resistance test”.	N/A
Manufacturers, importers or authorised representatives shall provide user instructions in the form of a user manual on a free access website of the manufacturer, importer or authorised representative. Those instruction shall include instructions for battery maintenance, including the following:	N/A
impacts on battery lifetime related to exposure of the device to elevated temperatures, suboptimal charging patterns, fast charging and other known adverse factors	<ul style="list-style-type: none"> · High temperatures accelerate the decomposition and evaporation of the electrolyte within the battery and exacerbate side reactions in the cathode and anode materials, leading to a permanent increase in internal resistance and a permanent loss of capacity. · Fast charging is inherently safe, but high currents generate more heat and place greater stress on the lithium-ion intercalation/deintercalation process within the battery, which slightly accelerates aging over the long term. Charging at fast speeds in high-temperature environments is particularly damaging, effectively doubling the harm.

Required Information/ Informations requises

<p>effects of switching off radio connections, such as WiFi, Bluetooth, on power consumption</p>	<ul style="list-style-type: none">· When 2.3.4.G mode is disabled, the standby current of the mobile phone can be reduced from 1–5 mA to 0.1–0.5 mA. The main consumption comes from the sleep state of the baseband processor and minimal background system activities. Disabling Wi-Fi, especially turning off advanced options such as "Scanning always available," can eliminate the power consumption caused by these periodic wake-ups.· Simply turning off Bluetooth offers a nearly negligible improvement in pure standby battery life (potentially less than 1%).
<p>information about whether the device supports other features, which extend battery lifetime, such as smart charging and about how these features are activated or under which conditions they work best.</p>	<p>not available</p>
<p>Where the package does not include a charger, the user instructions referred to in point 2 shall include the following information: "For environmental reasons this package does not include a charger. This device can be powered with most USB power adapters and a cable with USB Type-C plug."</p>	<p>For environmental reasons this package does not include a charger. This device can be powered with most USB power adapters and a cable with USB Type-C plug."</p>

Thank you ! / Merci !